

EXCErator®/Cosmic Spin® Information

Features

Professional Ball Bearing Yo-Yo

Made of impact-resistant polycarbonate plastic

Prominently features the NED message

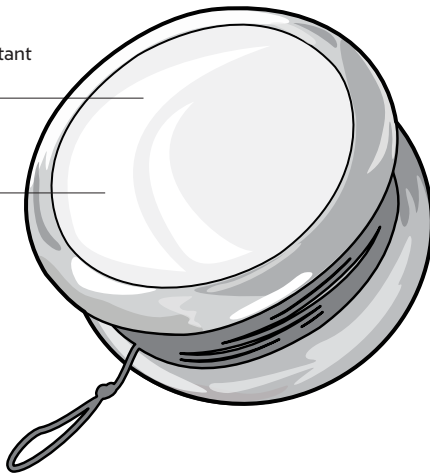

- Twist apart (for knot removal)
- Steel ball bearing (for friction reduction)
- Six parts

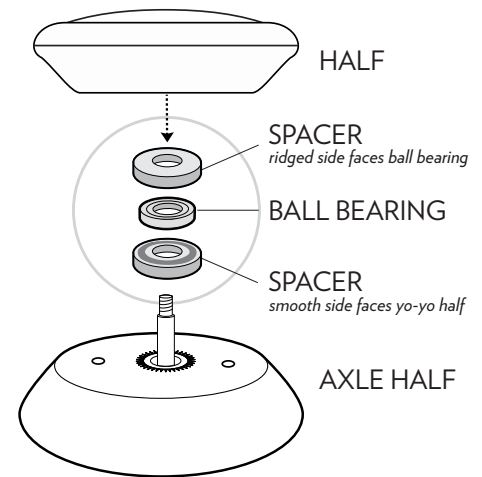

Common Questions

For related videos and downloads visit www.theNEDshow.com/kidz

How do I wind up the string when it keeps slipping?

Wrap the string over your finger once. Then continue to wrap the string around the axle, to the side of your finger, 2-3 times. Simply remove your finger and gently finish winding up the string. The finger loop will disappear when you throw the yo-yo down.

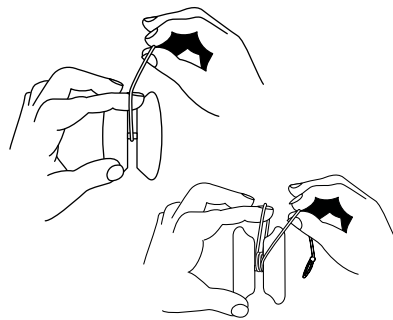

Can the EXCErator/Cosmic Spin be set for easy play?

The Ball Bearing yo can be hitched for easy play, as well as unhitched for advanced tricks. It will take five wraps to make it stop 'sleeping' completely, for easier tricks. See the "How to add the hitch for beginner tricks" instructions in the section below.

Adding wraps to make a hitch (for easy play)

The Ball Bearing Yo comes as a sleeper

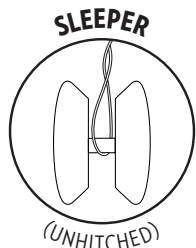

1-2 wraps

1. Pinch the string about 3 inches (7cm) above your yo.

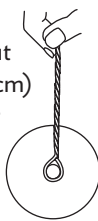

2. As you look down at your yo-yo, spin it counterclockwise until the strands of string split apart.

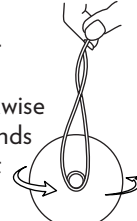

3. Add one wrap at a time until there are five wraps around the axle.

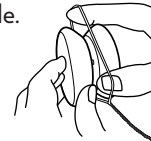

4. Let go of the pinched string, and the yo-yo will spin, returning the string to its natural position. Now you are ready for easy play!

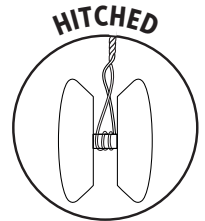

5 wraps

More Info

NEVER GIVE UP ★ ENCOURAGE OTHERS ★ DO YOUR BEST®

- Visit theNEDshow.com/videos for how-to videos.
- Contact **Customer Care** for replacement parts. To order parts online visit shopNED.com.
- Questions? Visit the **Product Help Center** at www.theNEDshow.com/product-help.



THE NED SHOW®
There's a *Champion* in Every Kid!®